

# R465-Clamps

The S-5!<sup>®</sup> R465 - clamps, made of Aluminium, are specially designed for the profiles Zambelli RIB-ROOF 465, Domico GBS and similar.

The exact fit with the set screws on both sides are the basis for the high holding forces.

The R465-Clamp with 4 set-screws, one M8 thread on top and M8 stainless steel bolt is used for heavy demands e.g. fall protection systems and in the S-5! ColorGard<sup>®</sup> snow retention system.

**PU: R465-Clamp 30 pieces per box** (not on stock).

The R465-Mini with 2 set-screws and a M8-thread on top is utilized in various instances when multiple clamps are required for the attachment of rigid objects to the seams e.g. S-5-PVKIT<sup>®</sup> 2.0, rail systems, walkways, RoofTech tube snow retentions, signs, satellite dishes, cable trays, pipes, etc.

The S-5!<sup>®</sup> Mini clamps are now supplied without M8x16 stainless steel screws. These screws can be ordered separately from us. PU: 100 pieces per box.

**PU: R465-Mini: 50 pieces per box.**

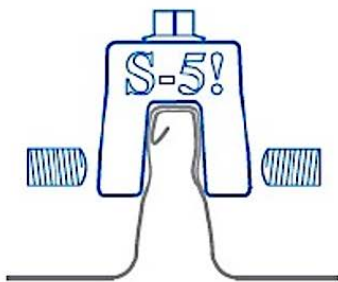

Mounting on RIB-ROOF 465 Profile

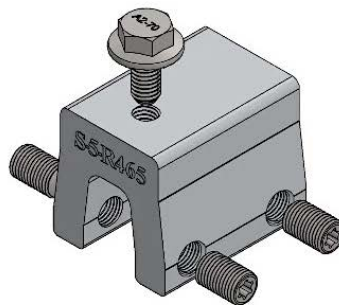

R465-Clamp



R465-Mini



**Examples of applications:** rail systems, ColorGard<sup>®</sup> snow guard, solar mounting, steps, handrails, walkways, etc..

## Tested holding strength of the S-5!<sup>®</sup> Clamps

In contrast to plagiarism and conventional seam clamps, only the *original* S-5!<sup>®</sup> Clamps are all multiple tested on many different materials and profiles by a third-party accredited US-lab. This type of test tests the clamp itself and the connection of the clamp to the profile under test conditions. Tests made with load pulling parallel (shear) to seam and with load pulling normal (tensile) to seam.

The result of all tests was, with very few exceptions, that the load capacity of each individual S-5!<sup>®</sup> clamp is stronger than the load capacity of the roof panels or profiled sheets and their attachment to the supporting structure. This applies not only to the S-5!<sup>®</sup> Clamps but also to the S-5!<sup>®</sup> Mini clamps.

**Please don't hesitate to contact us for more information, the test results and technical assistance.**

# R465-Clamps

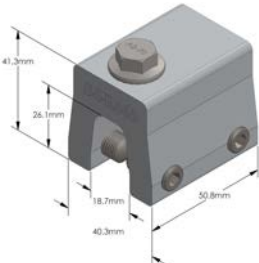

R465-Clamp

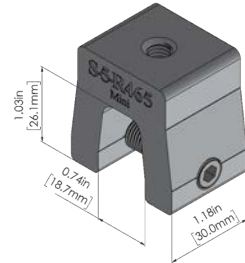

R465-Mini

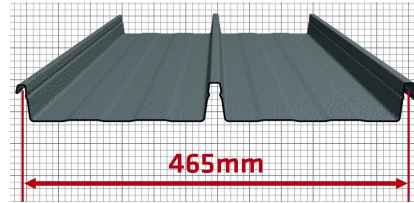

Size RibRoof R465 profile

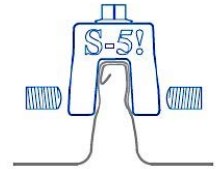

## To install the R465-Clamps:

- Partially thread all setscrews into the clamp by hand.
- Position the clamp at desired location along the seam with the bolt hole in the correct (upslope or downslope) orientation. Mount the clamps only on the overlapping seams of the roofing.
- Don't fix the clamps on or beside the clips because the thermal elongation of the panels may not be hindered!
- Use a screw gun and the included S-5! bit tip to tighten the two (one in the Mini) upslope setscrews until flush with seam wall. Next, tighten the two downslope setscrews until flush with seam wall.
- Finally, tension and re-tension each setscrew as the seam material compresses, i.e. tighten the first setscrew, then the second on opposite. Tighten them with a tightening force of 15-17 Nm. For flashings made of galvanized sheet steel with a thickness of more than 0.7mm, tighten the setscrews to 18-20 Nm (3 + 4).
- Then repeat until each setscrew achieves the recommended torque. When relying on published load values, setscrew tension should be verified using a calibrated torque wrench as indicated below to ensure the tool is consistently achieving the proper torque range.
- For applications utilizing an M8x16mm Hex Flange Bolt, tighten the M8 bolt to 18 Nm (160 inch pounds).
- For profile materials with a thickness of 0,7mm and less we offer a special stainless-steel saddle to fit in the inside of the clamp.

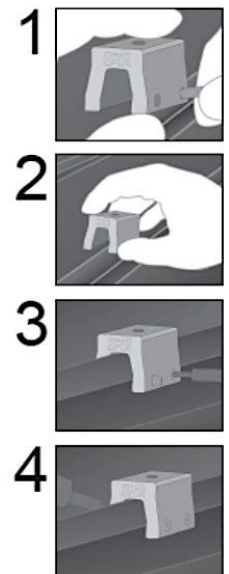

## Please note in general: (Please also note the S-5! installation instructions that are included in every S-5! product box)

- Installation with our products should only be carried out by specialists and specialist companies with qualifications for the respective installation and with experience in working on roofs. During installation, the warranties of all trades and the roof as well as the regulations for work on roofs (e.g. the use of fall protection, safety catches from an eaves height of 3m, accident prevention, building regulations, etc.) must be observed.
- In the event of non-observance of our installation instructions, when installing or assembling our products with components of the competition and when using and combining further components that were not purchased from us, we shall not accept any liability for any resulting defects and damage. The warranty is excluded in this respect.
- The suitability of the clamps for the intended metal roof profile must be checked before installation. Depending on the use of the respective clamp, it must be ensured that the forces transferred from the clamp to the seam can be absorbed by it and by the supporting structure. In particular, the snow and wind loads, the additional loads from the installations attached to the clamps, as well as the increased stresses in the edge and corner areas of the roof structure must be taken into account. A sufficient number of clamps must be provided. For statically relevant clamps, a distance of at least 500 mm from the standing seam profile end must be maintained.
- The building owner or operator is responsible for the stability of a structural system. The installer of the system is responsible not only for the system but also for the roof on which he installs the system. Anyone who installs a system on an existing roof without first checking its stability is violating existing law! The sufficient holding force of the roofing on the substructure must always be ensured. Verification must be provided by the client. In cases of doubt, a structural engineer must be consulted in advance to determine the load and its removal.
- In the case of handcrafted metal roofing on wooden formwork, the edge and corner areas should not be covered with PV-modules due to the limited load-bearing capacity of the roofing and the adhesion. In the middle area, it is usually not possible to skip over the seams. We therefore recommend installing clamps on each seam. The installation of g. PV systems represents a punctual load application, therefore we recommend reduced clip distances and screwed clips. The clamp should be installed and fixed between the clips to achieve optimum load distribution.
- The thermally induced change in length of the roofing must not be hindered! When mounting rigid objects such as rails, pipes, cable ducts, etc. on the clamps, these must be separated at regular intervals (after max. 3m) to limit deformation due to thermally induced changes in length (in longitudinal and transverse direction).
- The respective installation instructions do not release the executing company from clarifying the application possibilities and use of our products, also in connection with the other materials used, on the individual object in advance. The material properties of the respective metals, the combination with each other as well as the processing instructions and regulations of all manufacturers involved (also those of the metal roof) must be observed.
- RoofTech and S-5! recommend that the planned installation, PV system, snow guard, etc. be checked by a qualified specialist who is responsible for the snow and wind loads, the loads of the installation, the statics and assembly as well as the planning and construction of and on metal roofs.
- S-5! clamps are not suitable for use as fall protection or guardrails. The S-5! clamps may only be used for this purpose in a certified and approved fall protection system. The respective system provider for fall protection is responsible for this and must provide proof of this.
- The suitability of our products for the intended use is checked by the planner and user himself. If technical details are not described separately, this does not release the executing company from checking in individual cases and prior clarification of a technically correct issue. As a matter of principle, RoofTech GmbH, S-5!-Metal Roof Innovations Ltd. and our producers do not accept any responsibility for the installation, suitability and applications. S-5! products are protected by international patents of Metal Roof Innovations, Ltd.

Further installation instructions and information can be found on our homepage [www.rooftech.de](http://www.rooftech.de) or please request them from us.

RoofTech GmbH Benzstraße 21

Phone: +49 (0) 7031 769652-0

71101 Schönaich, Germany Email: [office@rooftech.de](mailto:office@rooftech.de)

[www.rooftech.de](http://www.rooftech.de)

